

Use & Care

G U I D E

Standard-Cleaning Gas Ranges

A Note to You	2
Range Safety	3-5
Getting to Know Your Range	6
Using Your Range	7
Caring for Your Range	16
Troubleshooting	22
Requesting Assistance or Service	24
Index	27
Warranty	28

1-800-44-ROPER

Call us with questions or comments.

TO THE INSTALLER: PLEASE LEAVE THIS INSTRUCTION BOOK WITH THE UNIT.

TO THE CONSUMER: PLEASE READ AND KEEP THIS BOOK FOR FUTURE REFERENCE.

MODELS FGP315E FGP325E FGP335E

PART NO. 3196295 Rev. B

ROPER[®]
Home Appliances

7196

A NOTE TO YOU

Thank you for buying a ROPER® appliance.

Your ROPER range gives you all the functionality of name brand appliances at a value price. To ensure that you enjoy years of trouble-free operation, we developed this Use and Care Guide. It is full of valuable information about how to operate and maintain your appliance properly and safely. Please read it carefully.

Also, complete and mail the **Product Registration Card** provided with your appliance. The card helps us notify you about any new information on your appliance.

Please record your model's information.

Whenever you call to request service for your appliance, you need to know your complete model number and serial number. You can find this information on the model and serial number plate (see the diagram on page 6 for the location of the plate). Also, record the other information shown in the next column.

Model Number _____
Serial Number _____
Purchase Date _____
Dealer Name _____
Dealer Address _____
Dealer Phone _____

Keep this book and the sales slip together in a safe place for future reference.

Our Consumer Assistance Center number is toll-free.

1-800-44-ROPER
(1-800-447-6737)

RANGE SAFETY

Your safety is important to us.

This guide contains safety statements under warning symbols. Please pay special attention to these symbols and follow any instructions given. Here is a brief explanation of the use of the symbol.



This symbol alerts you to hazards such as fire, electrical shock, or other injuries.

	<p style="text-align: center;">⚠ WARNING</p> <p style="text-align: center;">Tip Over Hazard</p> <p>Connect anti-tip bracket to the range. Reconnect anti-tip bracket, if the range is moved. Do not push down on the open oven door. Follow the Installation Instructions. Do not let children climb onto the oven door. Failure to follow these instructions can result in death, burns, or other injury.</p>
---	--

For more information, see "The anti-tip bracket" on page 15.

IMPORTANT SAFETY INSTRUCTIONS

READ AND SAVE THESE INSTRUCTIONS

Gas ranges have been thoroughly tested for safe and efficient operation. However, as with any appliance, there are specific installation and safety precautions which must be followed to ensure safe and satisfactory operation.

WARNING: If the information in this manual is not followed exactly, a fire or explosion may result causing property damage, personal injury or death.

- Do not store or use gasoline or other flammable vapors and liquids in the vicinity of this or any other appliance.
- **WHAT TO DO IF YOU SMELL GAS**
 - Do not try to light any appliance.
 - Do not touch any electrical switch; do not use any phone in your building.
 - Immediately call your gas supplier from a neighbor's phone. Follow the gas supplier's instructions.
 - If you cannot reach your gas supplier, call the fire department.
- Installation and service must be performed by a qualified installer, service agency or the gas supplier.

continued on next page

General

- Install or locate the range only in accordance with the provided Installation Instructions. The range must be installed by a qualified installer. The range must be properly connected to the proper gas supply and checked for leaks. The range must also be properly connected to the electrical supply and grounded.
- Gas fuels and their use in appliances can cause minor exposures to benzene, formaldehyde, carbon monoxide, and soot, primarily from incomplete combustion. Significant exposure to these substances could cause cancer or reproductive harm. Properly adjusted burners with a blue, rather than a yellow, flame will minimize incomplete combustion. Venting with a hood or an open window will further minimize exposure.
- Do not store things children might want above the range. Children could be burned or injured while climbing on it.
- Do not leave children alone or unattended in area where the range is in use. They should never be allowed to sit or stand on any part of the range. They could be burned or injured.
- Do not operate the range if it is damaged or not working properly.
- Do not use the range for warming or heating the room. Persons could be burned or injured, or a fire could start.
- Do not attempt to light the oven burner during a power failure. Personal injury could result. Reset the oven controls to the off position if there is a power failure.
- Use the range only for its intended use as described in this manual.



- Do not touch surface burners, areas near surface burners, or interior surfaces of oven. Areas near surface burners and interior surfaces of an oven become hot enough to cause burns. During and after use, do not touch, or let clothing or other flammable materials contact surface burners, areas near surface burners, or interior surfaces of oven until they have had sufficient time to cool. Other surfaces of the range, such as the oven vent opening, the surface near the vent opening, the cooktop, and the oven door, could also become hot enough to cause burns.



- Do not wear loose or hanging garments when using the range. They could ignite if they touch an open flame and you could be burned.
- Use only dry pot holders. Moist or damp pot holders on hot surfaces could result in burns from steam. Do not let pot holder touch an open flame. Do not use a towel or bulky cloth for a pot holder. It could catch on fire.
- Keep range vents unobstructed.
- Do not heat unopened containers. They could explode. The hot contents could cause burns and container particles could cause injury.
- Use only cookware approved for oven use. Follow cookware manufacturer's instructions, especially when using glass or plastic cookware.
- Do not store flammable materials on or near the range. The fumes could create an explosion and/or fire hazard.
- Do not use the oven for storage.
- Do not use aluminum foil to line area around burners, oven bottom, or any other part of the range.
- Never use a match or other flame to look for a gas leak. Explosion and injury could result.
- Know where your main gas shutoff valve is located.

When using the cooktop

- Make sure the cookware you use is large enough to contain food and avoid boilovers and spill-overs. Heavy splattering or spillovers left on a range could ignite and burn you. Pan size is especially important in deep fat frying.
- Check to be sure glass cookware is safe for use on the range. Only certain types of glass, glass-ceramic, ceramic, earthenware, or other glazed cookware are suitable for cooktops without breaking due to the sudden change in temperature.
- Never leave surface burners unattended at high heat settings. A boilover could result and cause smoking and greasy spillovers that could ignite.



- Turn pan handles inward, but not over other surface burners. This will help reduce the chance of burns, igniting of flammable materials, and spills due to bumping of the pan.
- Do not use decorative covers or trivets over the surface burners.

When using the oven

- Always position the oven rack(s) in desired location while oven is cool.
- Use care when opening oven door. Let hot air or steam escape before removing or replacing food.

Grease

- Grease is flammable. Do not allow grease to collect around cooktop or in vents. Wipe spillovers immediately.



- Do not use water on grease fires. Never pick up a flaming pan. Smother flaming pan by covering with a well-fitting lid, cookie sheet, or flat tray. Flaming grease outside of pan can be extinguished with baking soda or, if available, a multipurpose dry chemical or foam-type extinguisher.

Care and cleaning

- Do not clean door heat seal. It is essential for a good seal. Care should be taken not to rub, damage, or move the seal. Clean only parts recommended in this Use and Care Guide.
- Do not repair or replace any part of the range unless specifically recommended in this manual. All other servicing should be referred to a qualified technician.
- Any additions, changes, or conversions required in order for this appliance to satisfactorily meet the application needs must be made by a Roper service company or Qualified Agency.
- Disconnect the electrical supply and the gas supply at the shutoff valve near the range before servicing the range.

- READ AND SAVE THESE INSTRUCTIONS -

GETTING TO KNOW YOUR RANGE

This section contains captioned pictures of your range. Use them to learn where all parts and features are and what they look like. Use the page references to help you quickly find out more about the part or feature you are interested in.

(Model FGP335E shown)

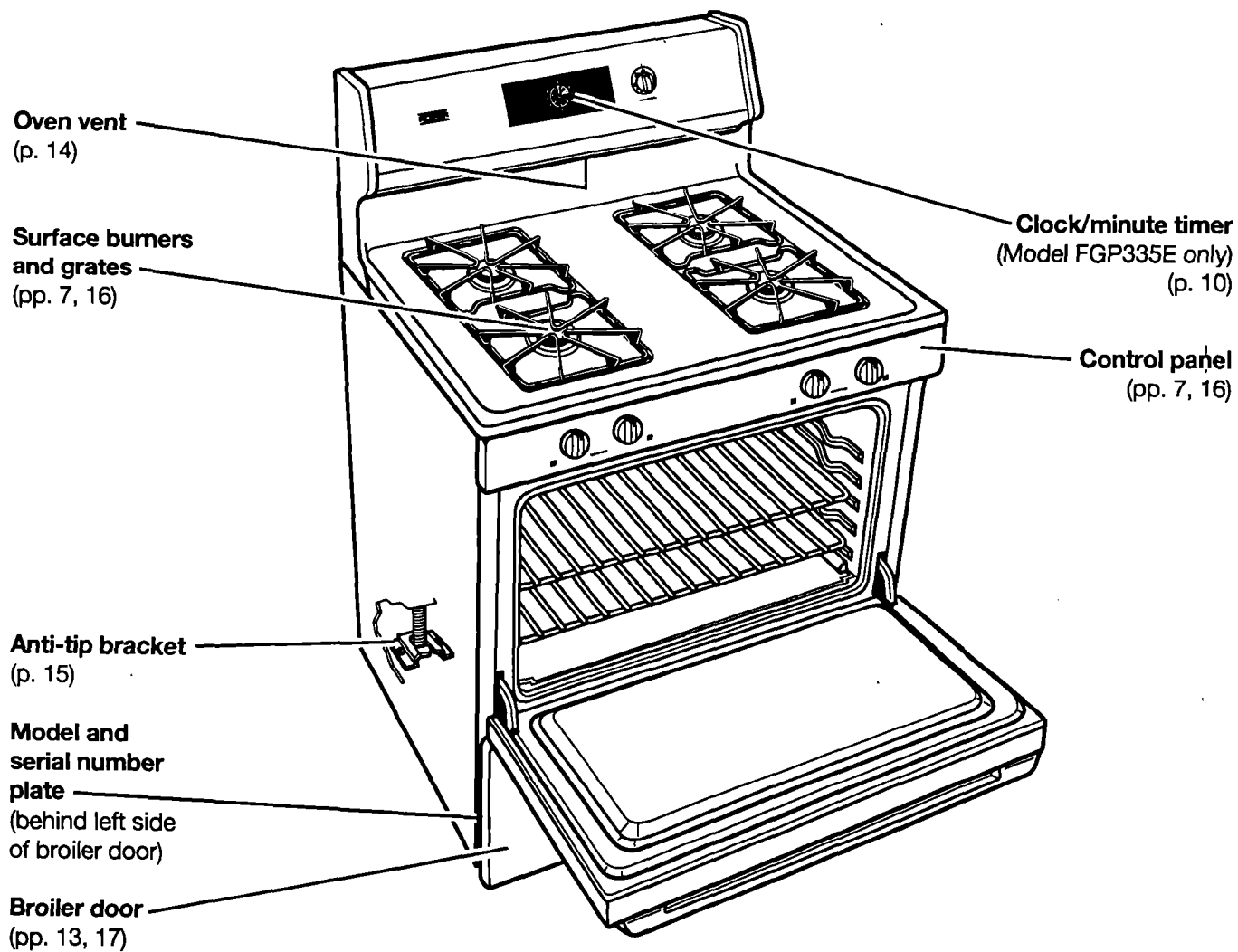

CONTROL PANEL

Surface burner marker (shows which burner you are setting)

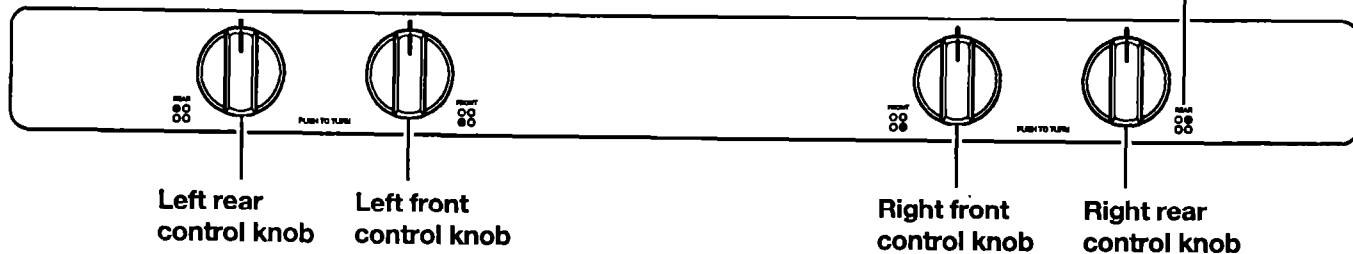

USING YOUR RANGE

To get the best cooking results, you should use your range the correct way. This section tells you what you need to know to use your range safely and efficiently.

USING THE SURFACE BURNERS

⚠ WARNING

Carbon Monoxide Poisoning Hazard
Do not operate with a yellow flame.
Doing so can result in death, heart attack, or convulsions.

Your range comes with electric ignitors. Electric ignitors automatically light the burners each time you turn the control knobs to LIGHT.

Using the control knobs

- Push in the control knob and turn it **counter-clockwise** to the LIGHT position. The clicking sound is the ignitor sparking. Make sure the burner has lit.
- To stop the clicking sound after the burner lights, turn the control knob to the cook setting you want. The control knob has two

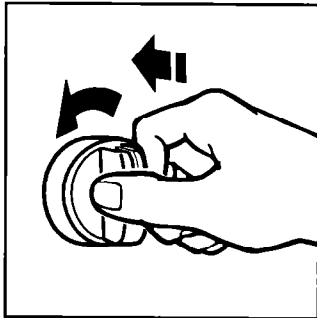

cook settings. However, you can set the control knob anywhere between HIGH and LOW.

NOTE: All four electric ignitors will click at the same time. However, the burner with the control knob turned to LIGHT is the one that will ignite.

Burner heat settings

Use the following chart as a guide.

SETTING	RECOMMENDED USE
LIGHT	● To light the burner.
HIGH	● To start foods cooking. ● To bring liquids to a boil.
Between HIGH and LOW	● To hold a rapid boil. ● To fry chicken or pancakes. ● For gravy, pudding, and icing. ● To cook large amounts of vegetables.
LOW	● To keep food warm until ready to serve.

Energy saving tips

- To help shorten your cooking time, use the least amount of liquid possible.
- Preheat your pans only when recommended and for the shortest time possible.
- Start your food on a higher heat setting, then turn the control to a lower setting to finish cooking.
- Place a filled pan on the burner grate before turning on the surface burner.

⚠ WARNING



Fire Hazard

Do not let the burner flame extend beyond the edge of the pan.

Turn off all control knobs when not cooking.

Failure to follow these instructions can result in death, fire, or burns.

NOTE: Do not leave empty cookware, or cookware which has boiled dry, on a hot surface burner. The cookware could overheat and damage the cookware or cooking product.

USING THE SURFACE BURNERS (CONT.)

In case of a prolonged power failure

You can manually light surface burners. Hold a lit match near a burner and turn the control knob to the LIGHT position. After the burner lights, turn the control knob to the setting you want.

Home canning information

The large diameter of most water-bath or pressure canners combined with high heat settings for long periods of time can cause damage to the cooktop.

To protect your range:

- For best results, use a canner which can be centered over the surface burner.
- Do not place your canner on 2 surface burners at the same time. Too much heat will build up and will damage the cooktop.

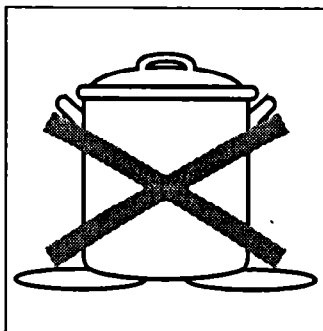

● Start with hot water. This reduces the time the control is set on high. Reduce the heat setting to the lowest position needed to keep the water boiling.

- Refer to your canner manual for specific instructions.

Cookware tips

- The pan should have a flat bottom, straight sides, and a well-fitting lid.
- Choose medium to heavy gauge (thickness) cookware.
- The pan material (metal or glass) affects how quickly and evenly the pan heats.
- When using glass or ceramic cookware, check to make sure it is suitable for use on surface burners.
- To avoid tipping, make sure pots and pans are centered on the grates.

POSITIONING RACKS AND PANS

General guidelines

Follow this section carefully to get the best cooking results.

- Before turning on the oven, place oven racks where you need them.
- To move a rack, pull it out to the stop, raise the front edge, and lift it out.
- Be sure the rack(s) is level.
- Use pot holders or oven mitts to protect your hands if rack(s) must be moved while the oven is hot.
- When baking/roasting with 1 rack, place the rack so the top of the food will be centered in the oven.
- When baking/roasting on 2 racks, arrange the racks on the 2nd and 4th rack guides from the bottom.
- Do not place items on the oven door when it is open.

Rack placement for specific foods:

FOOD	RACK POSITION
Frozen pies, large roasts, turkeys, angel food cakes	1st or 2nd rack guide from bottom
Bundt cakes, most quick breads, yeast breads, casseroles, meats	2nd rack guide from bottom
Cookies, biscuits, muffins, cakes, nonfrozen pies	2nd or 3rd rack guide from bottom

POSITIONING RACKS AND PANS (CONT.)

Extra oven rack position (roasting rack)

Use this rack position when roasting food too large to be placed on the first rack position.

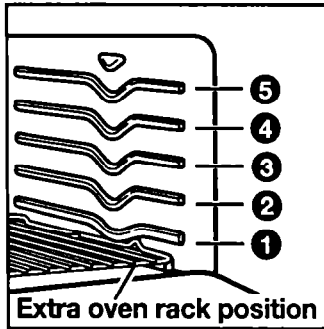

For proper roasting, follow these guide lines:

- The rack must be level.
- Use an adequate amount of liquid in the pan (meat juices or water) so your food does not get overdone.

- To pull the rack over the door you must tilt the rack up at the front. If the rack is loaded with food, tilting the rack could cause the food to spill. To avoid spilling, do not try to pull out the rack when removing large amounts of food.

Using insulated bakeware, ovenproof glassware, and dark metal pans

- When baking with insulated cookie sheets or baking pans, place them in the bottom third of the oven. You may need to increase the recommended baking times, so test for doneness before removing from the oven.
- When using ovenproof glassware or dark bakeware, reduce the oven temperature by 25°F but use the same baking time. Because these pans absorb heat, producing darker bottom browning and crispier crusts, place the rack in the center of the oven. When baking pies and bread, you can use the temperature suggested in the recipe.

FOR BEST AIR CIRCULATION

Hot air must circulate around the pans in the oven

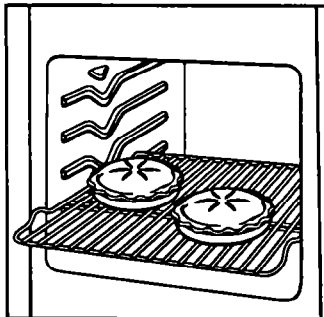

for even heat to reach all parts of the oven. This results in better baking.

- Place the pans so that one is not directly over the other.
- For best results, allow 1½-2 inches of space around each pan and between pans and oven walls.

- Use only 1 cookie sheet in the oven at a time.

Where to place pans:

WHEN YOU HAVE	PLACE
1 pan	In center of the oven rack.
2 pans	Side by side or slightly staggered.
3 or 4 pans	In opposite corners on each oven rack. Stagger pans so no pan is directly over another.

SETTING THE CLOCK (MODEL FGP335E)

1. Push in the minute timer knob and turn it clockwise until the clock shows the correct time of day.

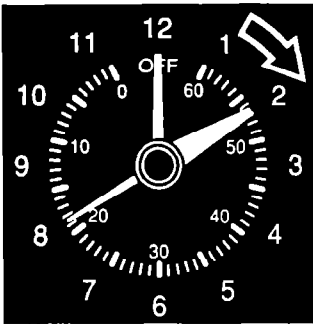

2. Let the minute timer knob pop out. Turn it clockwise until the minute timer hand points to OFF.

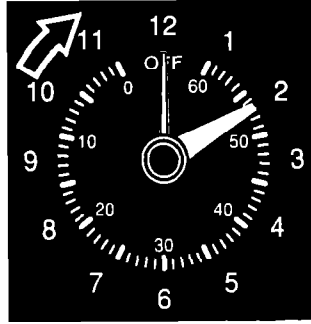

NOTE: The clock setting will change if you push in the knob when turning.

USING THE MINUTE TIMER (MODEL FGP335E)

The minute timer does not start or stop the oven. It works like a kitchen timer. Set it in minutes up to an hour. You will hear a buzzer when the set time is up.

NOTE: Do not push in the knob when setting the minute timer. Pushing in and turning the minute timer knob changes the clock setting.

1. Without pushing it in, turn the minute timer knob counterclockwise until the timer hand passes the setting you want.

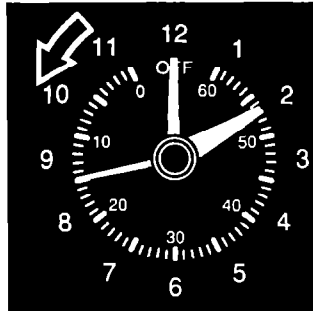

2. Without pushing it in, turn the knob back to the setting you want. When the time is up, a buzzer will sound. To stop the buzzer, turn the minute timer hand to OFF.

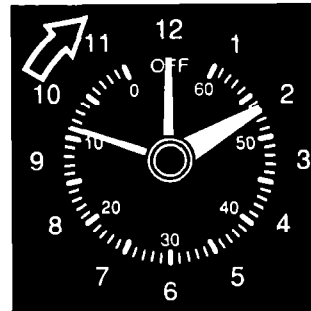

BAKING/ROASTING

IMPORTANT: Do not attempt to light the oven burner during a power failure. See "Range Safety" on page 4 for more information.

1. Place racks where you need them. For more information, see "Positioning racks and pans" on page 8.

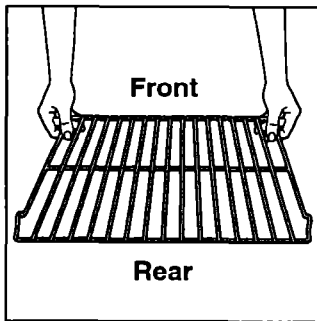

3. When baking, preheat the oven for 10 minutes, then put your food in the oven.

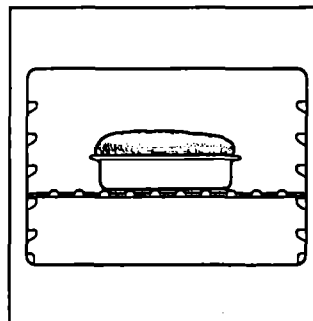

NOTE: Do not place your food directly on the oven bottom. If you want, place the food on the rack at the extra rack position. During baking/roasting, the oven burner will turn on and off to keep the same temperature setting.

2. Push in and turn the oven temperature control knob counterclockwise to the baking/roasting temperature you want. The oven burner will light by itself in 50-60 seconds.

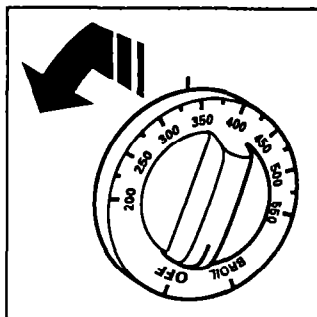

4. After baking/roasting, turn the oven temperature control knob clockwise to OFF.

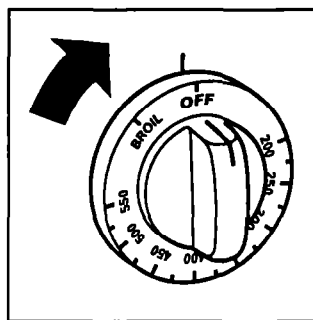

Energy savings tips

- "Oven peeking" can make cooking times longer and affect food quality.
- Rely on a timer to keep track of cooking time.
- Plan your meals for the most efficient use of the oven by cooking more than one food at a time.
- If possible, plan to bake while the oven is still hot after cooking.
- You don't have to preheat the oven when broiling or roasting.

Roasting tips

- For even cooking, place the meat on a rack in a shallow pan. This keeps the meat out of the drippings and allows the heat to circulate better.
- Use a meat thermometer for the most accurate doneness. Insert it so the tip is in the center of the largest muscle or thickest portion of the meat or poultry. Make sure the thermometer is not touching bone, fat, or the bottom of the pan.

ADJUSTING THE OVEN TEMPERATURE CONTROL

Although your new oven is properly adjusted to provide accurate temperatures, it may cook faster or slower than your old oven.

If you are not satisfied with the baking/roasting results, you can change the temperature calibration by following the steps below.

NOTE: DO NOT measure the oven temperature with a thermometer. Opening the oven door will lower the oven temperature and give you an incorrect reading. Also, the thermometer temperature reading will change as your oven cycles.

1. Make sure the oven temperature control knob is turned to the off position. Pull the knob straight off and flip it over.

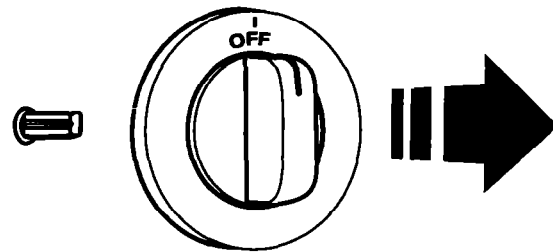

2. Loosen the locking screws inside the control knob. Note the position of the notches.

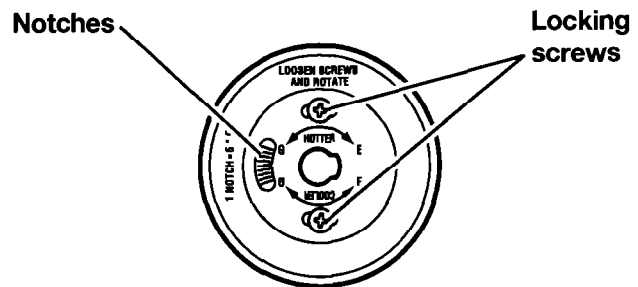

3. Adjust the temperature.

- **To lower the temperature**, hold the knob handle firmly and turn the skirt **clockwise** to move the tooth a notch to the "G" on the "COOLER" arrow.
- **To raise the temperature**, hold the knob handle firmly and turn the skirt **counterclockwise** to move the tooth a notch to the "G" on the "HOTTER" arrow.

Each notch equals about 5°F.

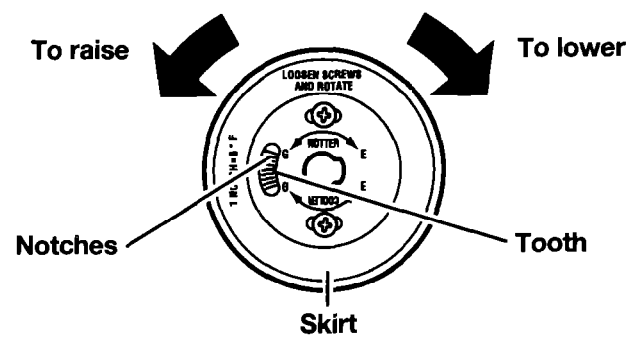

4. Tighten the locking screws and replace the control knob.

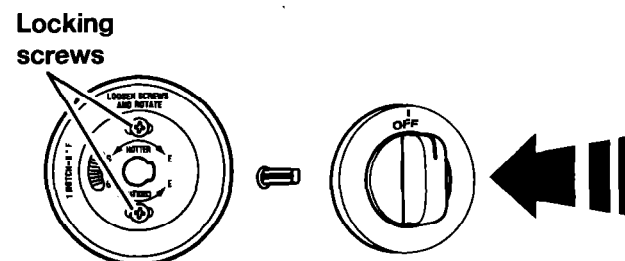

BROILING

The broiler is located below the oven door. Always broil with the broiler and oven doors closed.

NOTES:

- Do not step on or apply weight to the broiler door when it is open. This could damage the door.
- Do not preheat the broiler before using it. Completely close the broiler door during broiling.

1. Open the broiler door. Then pull out the broiler pan and grid.

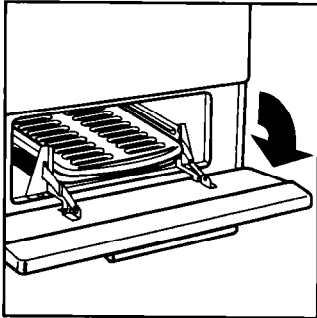

2. Place the broiler pan and grid so grease can drain down into the lower part of the broiler pan.

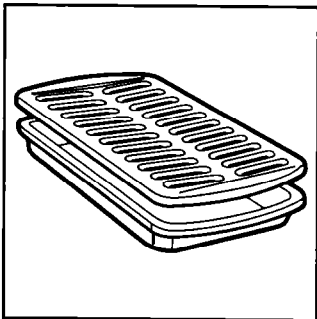

3. Before the broiler is turned on, place your food on the broiler pan. Then place the pan on the broiler bottom or one of the two ledges.

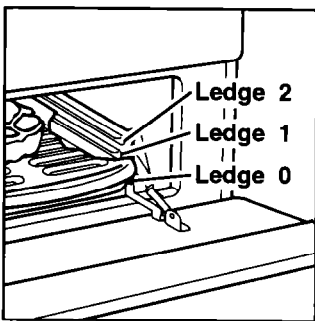

4. Close the broiler door.

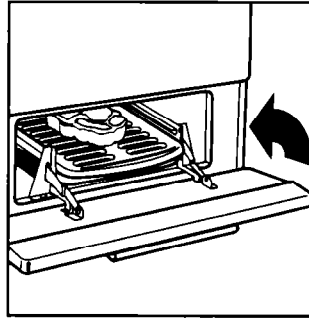

5. Push in and turn the oven temperature control knob counterclockwise to BROIL. The broiler will automatically light in 50-60 seconds.

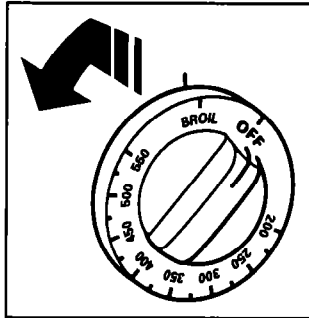

6. After broiling, turn the oven temperature control knob clockwise to OFF.

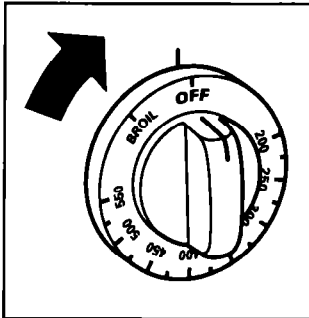

BROILING (CONT.)

Broiling guide

Recommended pan positions are numbered from bottom (0) to top (2) (see page 13). For best results, turn your meat after about $\frac{2}{3}$ of the broiling time. Turn chicken pieces after about $\frac{1}{2}$ of the broiling time. Very thin cuts, such as fish fillets, may not need to be turned at all. **You should rotate the broiler pan back to the front at the same time you turn the foods.**

MEAT	PAN POSITION	APPROXIMATE TIME (MINUTES)	
		SIDE 1	SIDE 2
Steak, 1" thick medium-rare medium well-done	1	10-12	5-6
		12-14	6-7
		16-17	8-9
Ground Meat Patties, $\frac{3}{4}$" thick, well-done	1	11-13	6-7
Pork Chops, 1" thick	0	19-21	9-10
Ham Slice, $\frac{1}{2}$" thick precooked	1	6-8	3-4
Frankfurters	1	5-6	2-3
Chicken			
bone-in pieces	0	15-17	15-17
boneless breasts	1	11-13	11-13
Fish, $\frac{1}{2}$-$\frac{3}{4}$" thick fillets	1	7-8	3-4

Times are guidelines only and may need to be adjusted to individual tastes.

THE OVEN VENT

Hot air and moisture escape from the oven through a vent that's near the middle of the backguard. The vent lets air circulate properly. Be careful not to block the vent, or you will get poor baking/roasting results.

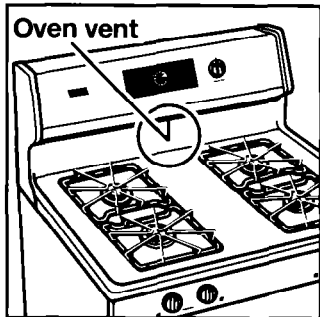

NOTE: Never store plastics, paper, or other items that could melt or burn near the oven vent, or any of the surface burners.

WARNING



Burn Hazard

Use pot holders when touching items left near oven vent.

Failure to do so can result in burns.

THE ANTI-TIP BRACKET

The range will not tip during normal use. However, the range can tip if you apply too much force or weight to the open door without the anti-tip bracket fastened down properly.

To make sure the anti-tip bracket is fastened into place:

- Look under the range (you may need a flashlight).

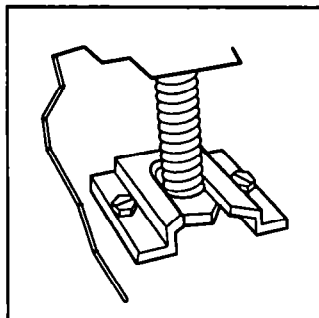

Check that a leveling foot is positioned under the bracket.

- See the Installation Instructions for further details.

⚠ WARNING



Tip Over Hazard

- **Connect anti-tip bracket to the range.**
- **Reconnect anti-tip bracket, if the range is moved.**
- **Do not push down on the open oven door.**
- **Follow the Installation Instructions.**
- **Do not let children climb onto the oven door.**
- **Failure to follow these instructions can result in death, burns, or other injury.**

CARING FOR YOUR RANGE

Your range is designed so you can care for it easily. You can do most cleaning with items found around your home. Cleaning your range whenever spills or soiling occurs will help to keep it looking and working like new.

	⚠ WARNING
	<p>Explosion Hazard</p> <p>Do not store flammable materials such as gasoline near the cooktop. Doing so can result in death, explosion, fire, or burns.</p>

CLEANING CHART

Use this chart to get specific information on cleaning your range. **Before cleaning, always make sure all controls are off and the range is cool.**

PART	HOW TO CLEAN
Control knobs	<ol style="list-style-type: none"> 1. Turn the knobs off and pull them straight away from the control panel. 2. Wash the knobs with a sponge and warm, soapy water. Rinse and dry them well. Do not soak them. Do not use steel wool or gritty cleansers, which can damage the finish of the knobs. 3. Replace the knobs. Make sure all knobs are turned off.
Control panel	<ul style="list-style-type: none"> ● Wash the panel with a sponge and warm, soapy water. Wipe the panel with clean water and dry it well. Do not use steel wool or gritty cleansers, which can damage the finish. <p style="text-align: center; margin: 5px 0;">OR</p> <ul style="list-style-type: none"> ● Wash the panel with a paper towel and spray glass cleaner. Do not spray the cleaner directly on the panel. Apply the cleaner to the paper towel.
Exterior surfaces (other than control panel)	<ul style="list-style-type: none"> ● Wash with a sponge and warm, soapy water. Wipe with clean water and dry well. ● Use a nonabrasive, plastic scrubbing pad on heavily soiled areas. ● Do not use gritty or harsh cleansers, which can damage the finish. <p>NOTE: Do not let foods containing acids (such as vinegar, tomato, or lemon juice) remain on the surface. Acids may remove the glossy finish. Also wipe up milk or egg spills when the cooktop is cool. Be careful when cleaning around the model and serial number plate; too much scrubbing could remove the numbers.</p>
Surface burner grates	<ul style="list-style-type: none"> ● Wash the grates with a nonabrasive plastic scrubbing pad and warm, soapy water. Rinse and dry well. For stubborn stains, clean with a scrubbing pad and/or a powdered cleanser and water. Repeat these cleaning steps as needed.

CLEANING CHART (CONT.)

PART	HOW TO CLEAN
Surface burners (see "Lift-up cooktop and surface burners" on page 18 for more information)	<ol style="list-style-type: none"> 1. Lift up the cooktop. (See page 18.) 2. Wipe off spills with a sponge and warm, soapy water right after the burner has cooled. <p>For cooked-on food:</p> <ol style="list-style-type: none"> 1. Remove the shipping screws (one on each side of both ignitors) with a Phillips screwdriver. Remove the burner from the support bracket. 2. Wash the burner with warm, soapy water and a nonabrasive plastic scrubbing pad or soak in a vinegar and water solution for 20-30 minutes. Then scrub it with a plastic scrubbing pad. For stubborn stains, clean with a scrubbing pad and/or a powdered cleanser and water. Repeat these cleaning steps as needed. 3. Rinse the burner with clean water and dry well. 4. If the ports are clogged, clean them with a straight pin. Do not enlarge or distort the ports. Do not use a wooden toothpick. <p>NOTE: Do not clean the surface burner in a dishwasher.</p>
Broiler pan and grid	<ul style="list-style-type: none"> ● Wash the pan and grid with a steel-wool pad and warm, soapy water. Rinse and dry well. <p>OR</p> <ul style="list-style-type: none"> ● Wash the pan and grid in a dishwasher.
Broiler	<ol style="list-style-type: none"> 1. Make sure the broiler is cool before cleaning. 2. After each use, wipe the interior with a warm, damp sponge. For heavily soiled areas, use a soapy steel-wool pad.
Oven racks	<ul style="list-style-type: none"> ● Wash with a steel-wool pad and warm, soapy water. Rinse and dry well.
Oven door glass (Models FGP325E and FGP335E)	<ul style="list-style-type: none"> ● Wash with a paper towel and spray glass cleaner or a nonabrasive plastic scrubbing pad and warm, soapy water. Wipe with clean water and dry well. ● Follow the directions that come with the cleaner.
Oven cavity	<ul style="list-style-type: none"> ● Wash with a sponge or steel-wool pad and warm, soapy water. Wipe with clean water and dry well. <p>OR</p> <ol style="list-style-type: none"> 1. Clean heavily soiled areas with a commercial oven cleaner. Follow the directions that come with the oven cleaner. (Place newspaper on the floor to protect the floor surface.) 2. Wipe well with clean water. <p>NOTES:</p> <ul style="list-style-type: none"> ● Use oven cleaners in a well-ventilated room. ● Do not let commercial oven cleaners contact the heat seal, thermostat, or exterior surfaces of the range. This will cause damage. ● For easier cleaning you can remove the oven door. Carefully follow the instructions on pages 19-20.

LIFT-UP COOKTOP AND SURFACE BURNERS

1. Remove the surface burner grates.

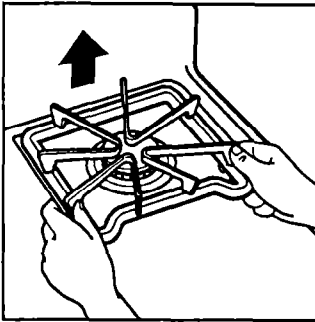

2. Lift the front of cooktop at both front corners until the support rods lock into place. **NOTE:** Do not drop the cooktop. Damage could result to the porcelain and the cooktop frame.

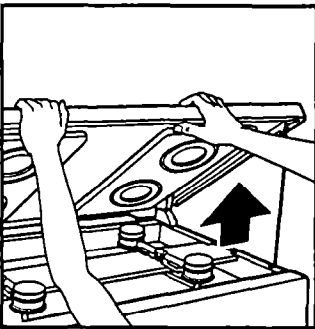

3. Wipe the surface under the cooktop with warm, soapy water and a sponge. Use a soap-filled plastic scrubbing pad on heavily soiled areas.

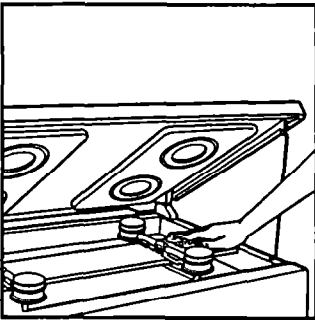

4. Wipe off the surface burners with warm, soapy water and a sponge after each use. To remove cooked-on food, soak the burners in a vinegar and water solution for 20-30 minutes. Then scrub them with a plastic scrubbing pad. (See page 17 for more information.)

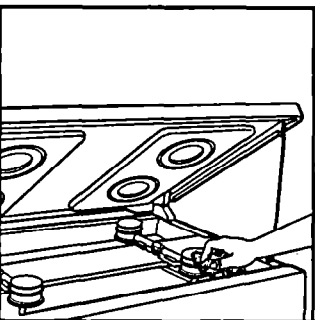

⚠ WARNING

Carbon Monoxide Poisoning Hazard
Do not operate with a yellow flame.
Doing so can result in death, heart attack, or convulsions.

5. Check the burner flames once in a while for proper size and shape as shown. A good flame is blue in color. If flames lift away from ports, are yellow, or are noisy, turn off the burner. Allow the burner to cool and follow Step 6. If you still have a problem, contact an authorized Roper service technician to check the air/gas mixture or see the Installation Instructions.

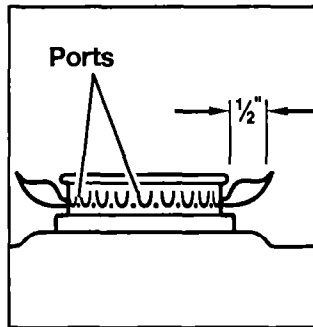

6. If the ports are clogged, clean with a straight pin. **DO NOT** enlarge or distort the ports. **DO NOT** use a toothpick to clean the ports. Toothpick pieces may clog the ports.

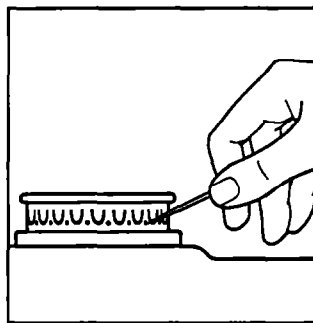

LIFT-UP COOKTOP AND SURFACE BURNERS (CONT.)

7. To lower the cooktop, lift the cooktop from both sides while pressing the support rods back to unlock them. Lower the cooktop into place.

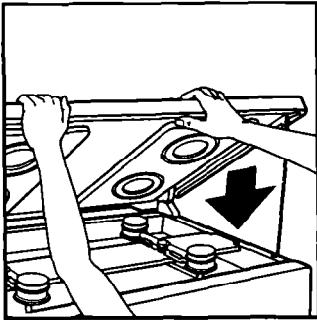

8. Replace the surface burner grates.

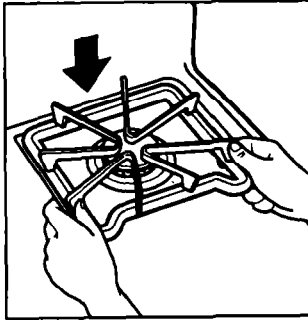

REMOVING THE OVEN DOOR

For normal use of your range, you do not need to remove the door. However, if you have to remove the door follow the instructions in this section.

Insert nail or screw here

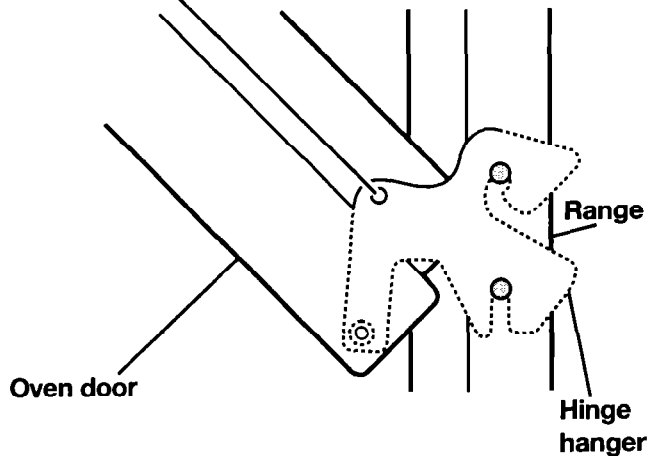

To remove:

1. Open the door about halfway. Insert nails or screws into both hinge hangers. **Do not remove them while the door is removed from the range.**

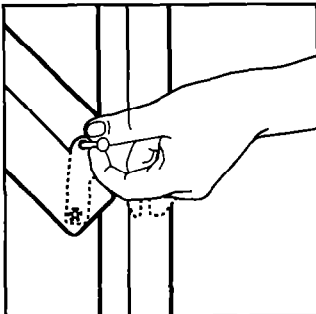

2. Close the door as far as the nails or screws will let you.

3. Rotate the door toward the range. Lift up the door until it stops. Do not use the door handle to lift the door. Rotate the door toward the floor and pull it toward you.

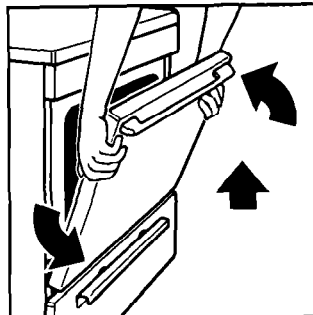

REMOVING THE OVEN DOOR (CONT.)

To replace:

NOTE: The nails or screws you inserted must still be in both sides of the door.

1. Grasp the door on the sides with your fingers on the front of the door and your thumbs on the inside surface.

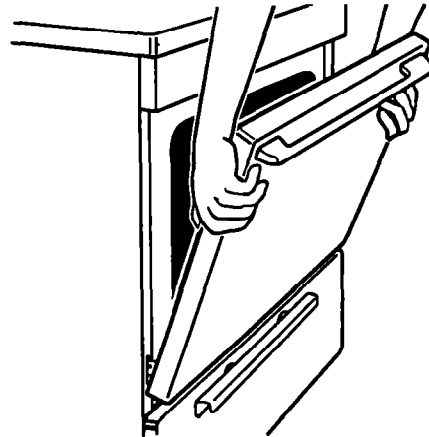

2. Rest the hinge hanger so that it is flat (at the bottom of the hinge hanger on the bottom of the front frame slot).
3. Position the door with the hinge hanger slots almost parallel to the front frame.
4. Push up and in until the hinge hanger slots become fastened to the range. Lower the door and rotate it slightly from the front to the back until the slots are fully fastened. The hinge hanger will be close to the bottom of the front frame slot.
5. Pull door open about halfway and remove the nails or screws.
6. Close the door.

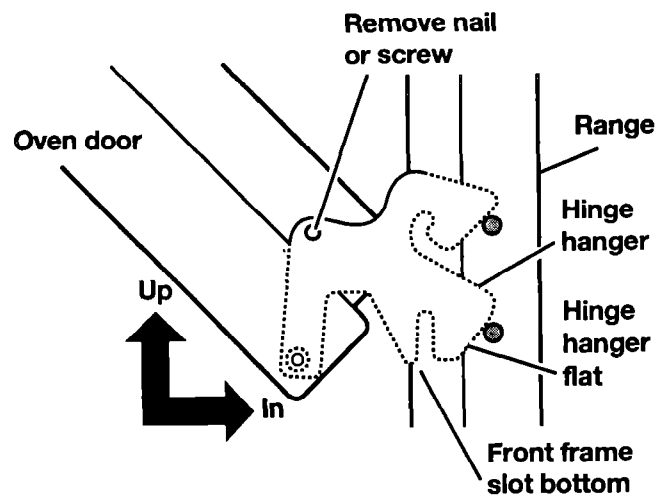

REMOVING THE OVEN BOTTOM

You can remove the panel in the oven bottom for cleaning.

To remove:

1. Let oven cool.
2. Remove the oven racks.
3. Remove the two hold-down screws at the rear of the oven. If the screws are too tight to remove by hand, use a screwdriver.

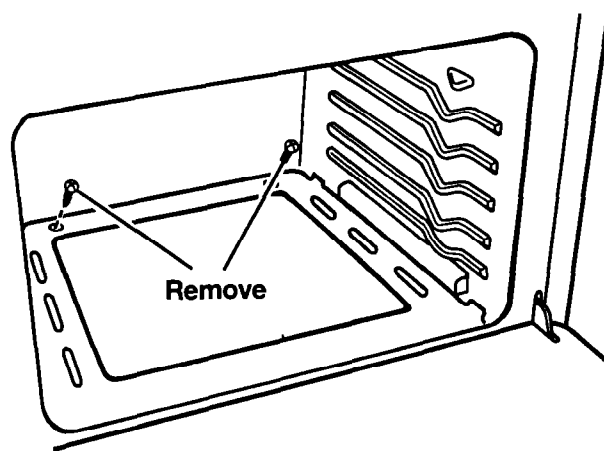

4. Place your fingers in the slots in the bottom panel and lift the rear of the panel up and back until the lip at the front of the panel is clear of the front frame of the oven cavity.
5. Lift the bottom up and out.

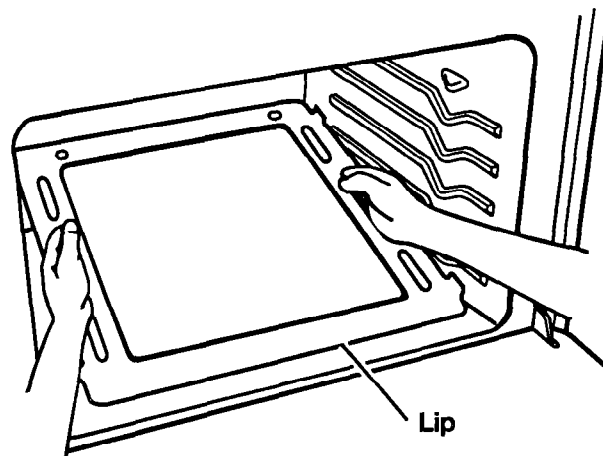

To replace:

Reverse the steps above.

TROUBLESHOOTING

Most cooking problems often are caused by little things you can find and fix without tools of any kind. Check the lists below and on the next page before calling for assistance or service. If you still need help, see "Requesting Assistance or Service" on page 24.

RANGE DOES NOT WORK

PROBLEM	CAUSE
Nothing works	<ul style="list-style-type: none">● The range is not properly connected to the gas supply. Contact an authorized Roper service technician to reconnect the range to the gas supply. (See the Installation Instructions.)● You have blown a household fuse or tripped a circuit breaker.● The control knob is not set correctly. Push in the control knobs before turning them.

OVEN/BROILER BURNER

PROBLEM	CAUSE
The oven does not work	<ul style="list-style-type: none">● You have not turned the oven temperature control knob to a temperature setting.● The main or regulator gas shutoff valve is in the off position. (See the Installation Instructions.)
The burner fails to light	<ul style="list-style-type: none">● The ignitor is broken. Contact an authorized Roper service technician to replace it.● You have blown a household fuse or tripped a circuit breaker.
The burner flames lift away from the ports, are yellow, or are noisy	<ul style="list-style-type: none">● The air/gas mixture is incorrect. Contact an authorized Roper service technician to check the air/gas mixture or see the Installation Instructions.

SURFACE BURNERS

PROBLEM	CAUSE
The burner fails to light	<ul style="list-style-type: none"> You have blown a household fuse or tripped a circuit breaker. The burner ports may be clogged. Clean them with a straight pin. (See pages 17 and 18.)
The burner flames are uneven	<ul style="list-style-type: none"> The burner ports may be clogged. Clean them with a straight pin. (See pages 17 and 18.)
The burner flames lift off the ports, are yellow, or are noisy when turned off	<ul style="list-style-type: none"> The burner needs cleaning. (See pages 17 and 18.) The air/gas mixture is incorrect. Contact an authorized Roper service technician to check the air/gas mixture or see the Installation Instructions.
The burner makes a popping noise when on	<ul style="list-style-type: none"> The burner is wet from washing. Let it dry.

COOKING RESULTS

PROBLEM	CAUSE
Cooking results are not what you expected	<ul style="list-style-type: none"> The oven temperature seems too low or too high. See "Adjusting the oven temperature control" on page 12 to adjust the oven temperature. You did not preheat the oven before baking (if called for in the recipe). The recipe you are using may need to be altered to improve the taste or appearance of the food. You are using a pan that is not the correct type or size. Refer to a reliable cookbook or recipe for the recommended pan type and size. There is not enough air space around the pan when baking. Allow 1½ to 2 inches of air space on all sides of the pan. The flame size does not fit the cookware being used. When broiling, you have not completely closed the broiler door. The flow of combustion and/or ventilation air to the range is blocked. Make sure nothing is blocking the middle front of the backguard or the floor right in front of the broiler. The range is not level. (See the Installation Instructions.)

If none of these items are causing your problem, see "Requesting Assistance or Service" on page 24.

REQUESTING ASSISTANCE OR SERVICE

To avoid unnecessary service calls, please check "Troubleshooting" on pages 22-23. It may save you the cost of a service call. If you still need help, follow the instructions below.

IF YOU NEED ASSISTANCE OR SERVICE

Call our Consumer Assistance Center toll free at

1-800-44-ROPER (1-800-447-6737).

Our consultants are available to assist you.

When calling:

Please know the purchase date, and the complete model and serial number of your appliance (see page 2). This information will help us better respond to your request.

Our consultants provide assistance with:

- Features and specifications on our full line of appliances
- Installation information
- Use and maintenance procedures



- Accessory and repair parts sales
- Do-it-yourself repair help
- Specialized customer assistance (Spanish speaking, hearing impaired, limited vision, etc.)
- Referrals to local dealers, service companies, and repair parts distributors

To locate an authorized servicer in your area, you can also look in your telephone directory Yellow Pages.

IF YOU NEED REPLACEMENT PARTS

If you need to order replacement parts, we recommend that you only use FSP® factory authorized parts. FSP replacement parts will fit right and work right, because they are made to the same exacting specifications used to build every new ROPER® appliance.

To locate FSP replacement parts in your area, call our Consumer Assistance Center telephone number or your nearest authorized service center.

FOR FURTHER ASSISTANCE

If you need further assistance, you can write to us with any questions or concerns at:

Roper Brand Home Appliances
Consumer Assistance Center
c/o Correspondence Dept.
2000 North M-63
Benton Harbor, MI 49022-2692

Please include a daytime phone number in your correspondence.

If the dealer, authorized servicer, and Roper Brand Appliance warrantor have failed to resolve your problem, you can contact the Major Appliance Consumer Action Program (MACAP). MACAP is a group of independent consumer experts that voice consumer views at the highest levels of the major appliance industry. MACAP will in turn inform us of your action.

Major Appliance Consumer Action Program
20 North Wacker Drive
Chicago, IL 60606

INDEX

This index is alphabetical. It contains all the topics included in this manual, along with the page(s) on which you can find each topic.

TOPIC	PAGE	TOPIC	PAGE
AIR CIRCULATION	9	MINUTE TIMER	10
ANTI-TIP BRACKET	15	MODEL AND SERIAL NUMBER	2
ASSISTANCE	24	OVEN	
BAKING		Bottom	21
Pans	9	Door	19
Racks	8, 9	OVEN TEMPERATURE	
Setting cycle	11	Adjusting	12
Tips	11	Setting	11
BROILING		OVEN VENT	14
Broiler	13	PANS	9
Grid	13	PARTS	6
Guide	14	RACKS	8, 9
Pan	13	ROASTING	
Setting cycle	13	Pans	9
CLEANING		Racks	8, 9
Broiler	17	Setting cycle	11
Broiler pan and grid	17	Tips	11
Control knobs	16	SAFETY	3-5
Control panel	16	SERVICE	24
Exterior surfaces	16	SURFACE BURNERS	
Oven cavity	17	Control knobs	7, 16
Oven door glass	17	Control setting guide	7
Oven racks	17	Power failures	8
Surface burners	17-19	Surface burner markers	6
Surface burner grates	16	TIPS	
CLOCK	10	Bakeware	9
CONTROL PANEL		Cookware	8
Burner heat settings	7	Roasting	11
Control knobs	7	Saving energy	7, 11
Surface burner markers	6	TROUBLESHOOTING	22-23
COOKWARE		WARRANTY	28
Canning	8		
Tips	8		
FEATURES	6		
LIFT-UP COOKTOP	18		

WARRANTY

ROPER® GAS RANGE

LENGTH OF WARRANTY	WE WILL PAY FOR
FULL ONE-YEAR WARRANTY FROM DATE OF PURCHASE	FSP® replacement parts and repair labor to correct defects in materials or workmanship. Service must be provided by an authorized Roper service company.
WE WILL NOT PAY FOR	
<p>A. Service calls to:</p> <ol style="list-style-type: none"> 1. Correct the installation of your range. 2. Instruct you how to use your range. 3. Replace house fuses or correct house wiring or plumbing. 4. Replace owner-accessible light bulbs. <p>B. Repairs when your range is used in other than normal, single-family household use.</p> <p>C. Pickup and delivery. Your range is designed to be repaired in the home.</p> <p>D. Damage to your range caused by accident, misuse, fire, flood, acts of God, or use of products not approved by us.</p> <p>E. Repairs to parts or systems caused by unauthorized modifications made to the appliance.</p>	

7/95

THIS ROPER APPLIANCE IS WARRANTED BY WHIRLPOOL CORPORATION. UNDER NO CIRCUMSTANCES SHALL IT BE LIABLE UNDER THIS WARRANTY FOR INCIDENTAL OR CONSEQUENTIAL DAMAGES. Some states do not allow the exclusion or limitation of incidental or consequential damages, so this exclusion or limitation may not apply to you.

This warranty gives you specific legal rights, and you may also have other rights which vary from state to state.

Outside the United States, a different warranty may apply. For details, please contact your authorized Roper dealer.

If you need service, first see the "Troubleshooting" section of this book. After checking "Troubleshooting," additional help can be found by checking the "Requesting Assistance or Service" section or by calling our toll-free telephone number, **1-800-44-ROPER (1-800-447-6737)**, from anywhere in the U.S.A.